



342 N. Co. Rd. 400 East
Valparaiso, IN 46383
219-464-8818 • Fax 219-462-7985
www.heatwagon.com

Installation and Maintenance Manual

Please retain this manual for future reference.

4200

***Construction
Heater***



For your safety: Do not use this heater in a space where gasoline or other liquids having flammable vapors are stored.

IMPORTANT INFORMATION! READ FIRST

The heater is designed for use as a construction heater under ANSI Z83.7a-1993. Heater is not intended for use in pest remediation. The primary purpose of construction heaters is to provide temporary heating of buildings under construction, alteration, or repair and to provide emergency heat. Properly used, the heater provides safe, economical heating. Products of combustion are vented into the area being heated.

The heater **IS NOT** designed as an Unvented Gas Fired Room Heater under ANSI-Z21.11.2 and **SHOULD NOT** be used in the home.

ANSI A119.2(NFPA 501C)-1987 Recreational Vehicle Standard prohibits the installation or storage of LP-gas containers even temporarily inside any recreational vehicle. The standard also prohibits the use of Unvented Heaters in such vehicles.

NFPA-58 1989 STANDARD FOR THE STORAGE AND HANDLING OF LIQUEFIED PETROLEUM GASES

Use of the heater must be in accordance with this Standard and in compliance with all governing state and local codes. Storage and handling of propane gas and propane cylinders must be in accordance with NFPA 58 and all local governing codes.

We cannot anticipate every use which may be made for our heaters. **CHECK WITH YOUR LOCAL FIRE SAFETY AUTHORITY IF YOU HAVE QUESTIONS ABOUT LOCAL REGULATIONS.**

Other standards govern the use of fuel gases and heat producing products in specific applications. Your local authority can advise you about these.

FOR YOUR SAFETY

DO NOT USE THIS HEATER IN A SPACE WHERE GASOLINE OR OTHER LIQUIDS HAVING FLAMMABLE VAPORS ARE STORED OR USED.

CONSTRUCTION HEATER GENERAL HAZARD WARNING:

Failure to comply with the precautions and instructions provided with this heater, can result in death, serious bodily injury and property loss or damage from hazards of fire, explosion, burn, asphyxiation, carbon monoxide poisoning, and/or electrical shock.

Only persons who can understand and follow the instructions should use or service this heater.

If you need assistance or heater information such as an instruction manual, labels, etc., contact your local Heat Wagon dealer or the manufacturer.

W A R N I N G

Fire, burn, inhalation, and explosion hazard. Keep solid combustibles, such as building materials, paper or cardboard, a safe distance away from the heater as recommended by the instructions. Never use the heater in spaces which do or may contain volatile or airborne combustibles, or products such as gasoline, solvents, paint thinner, dust particles or unknown chemicals.

Not for home or recreational vehicle use!

Installation and Maintenance Manual

Model 4200

Construction Heater

Table of Contents:

	Page
Specifications	4
Installation	5
Proper Set Up	6
Hose Sizing	6
Cord Sizing	6
Operating Instructions	8
Sequence of Component Operation	9
Trouble Shooting	10
Preventive Maintenance	11
Parts Breakdown	12-13
Wiring Diagrams	14-19

WARRANTY

All new Heat Wagon and Sure Flame heaters and fans are guaranteed against defective materials and workmanship for one (1) year from invoice date.

Warranty repairs may be made only by an authorized, trained and certified Heat Wagon dealer. Warranty repairs by other entities will not be considered. Warranty claims must include model number and serial number.

LIMITATIONS

Warrant claims for service parts (wear parts) such as spark plugs, igniters, flame rods will not be allowed. Diagnostic parts such as voltage meters and pressure gauges are not warrantable.

Evidence of improper fuel usage, fuel pressures outside of manufacturer's specification, poor fuel quality, and improper electric power, misapplication or evidence of abuse may be cause for rejection of warranty claims.

Travel time, mileage and shipping charges will not be allowed. Minor adjustments of heaters are dealers' responsibility. Defective parts must be tagged and held for possible return to the factory for 60 days from date of repair. The factory will provide a return goods authorization, (RGA) for defective parts to be returned.

No warranty will be allowed for parts not purchased from Heat Wagon.



342 N. Co. Rd. 400 East • Valparaiso, IN 46383
219-464-8818 • 888-432-8924 • Fax 800-255-7985
www.heatwagon.com

SPECIFICATIONS

Model No. 4200

Designed to ANSI Z83.7-1990 Standard Construction Heater
Gases: Natural or Propane
Capacity: 5,000,000/6,000,000/7,000,000 Btu/h maximum
Orifice Size: 19/64" - 21/64" - 3/8", Nat
7/32" - 15/64" - 1/4", LP
Blower: 27,500 CFM, 33,500 CFM, 40,000 CFM
Electrical Rating: 240V 60 amps, Single Phase (4210)
240V 40/50/60 amps, Three Phase
480V 25/30/40 amps, Three Phase
Minimum Temperature Rating: Minus 40 degrees F

Gas Supply:	Inlet Pressure		Manifold Pressure
	Max PSI	Min PSI	
Propane	250 lbs.	30 psi	15 psi
Natural Gas	250 lbs.	30 psi	15 psi

Inlet Connection:

Model 4200 (LP) 1/2" FNPT
Model 4200 (Nat/Vap) 1/2" FNPT

Maximum Duct Length, Straight:

400/500/600 Ft. @ 42" Diameter

Weight (approximate):

1200 lbs/ 1210 lbs/ 1420 lbs

INSTALLATION

The Heat Wagon Model 4200 Series is a direct fired gas heater intended to be used primarily for the temporary heating of building under construction, alteration, or repair. Since all the products of combustion are released into the area being heated, it is imperative that adequate ventilation is provided. The flow of supply air and combustion gases must not be obstructed in any way.

1. The heater is designed for indoor or outdoor installation in a horizontal position. Allow the following clearances from any combustible material or fuel containers.

Front Outlet:	10 feet	Sides:	2 feet
Intake:	1.5 feet	Top:	4 feet

Also make sure that no flammable vapors are present in the space where the heaters is being used.

2. The heater should be inspected before each use, and at least annually by a qualified service person.
3. The hose assembly must be inspected prior to each use of the heater. If it is evident that there is excessive abrasion or wear, or the hose is cut, it must be replaced prior to the heater being put into operation. The replacement hose assembly shall be that specified by the manufacturer. See parts list.
4. When connecting the heater to a natural gas or propane supply line ensure that the pressure at the heater inlet is within the specified range. Excessive pressure (over 250 psig) will damage the controls and void the warranty.
5. Connect the hose assembly to the heater gas inlet elbow. The elbow has a 1/2" Female NPT thread. The hose assembly is supplied with a swivel connector to avoid kinking or twisting the hose. Use a minimum inside diameter of 1/2" on LP or 3/4" on natural gas installations. Ensure that the hose assembly is protected from traffic, building materials, and contact with hot surfaces.
6. After installation, check hose assembly for gas leaks by applying a soap and water solution to each connection.
7. Connect the heater to an adequate electrical supply as specified on the rating plate. For protection against shock hazard the supply cord should be connected directly into a properly grounded fused disconnect.
8. Replacement parts are available from any Heat Wagon distributor or by calling 1-888-432-8924 for parts information.

PROPER SET UP

(NOTE: The 4200 Series must be specifically set up for the type of available fuel PRIOR to installation)

Model 4200 Series with built-in vaporizer. The heater will use 55-77 gallon of L.P. per hour. Use at least two 1000 gal. Liquid withdrawal tank. This will insure 20 hours of continuous operation.

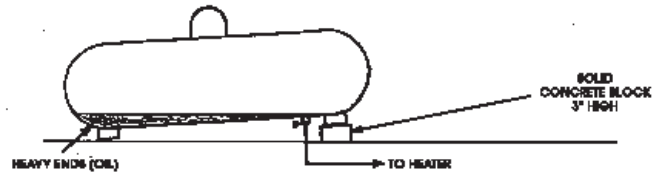

When running unit on Liquid Propane, the heater must be set up outside of the building, forcing the heat through a building opening.

- Hose size for Liquid Propane
-up to 50' 1/2" ID
- Keep hose length as short as possible.

<u>LARGE PROPANE STORAGE TANK VAPORIZATION RATE</u>				
<u>TANK SIZE:</u>	<u>MAXIMUM WITHDRAWAL RATE (BTUH):</u>			
	40"	30"	20"	0"
500 gallon	480,000	420,000	360,000	300,000
1000 gallon	850,000	740,000	640,000	530,000

Model 4200 Series, if setup for Vapor Propane withdraws 5,000,000 to 7,000,000 BTU's per hour. Proper Tank sizing is essential. A propane tank can only make X amount of Vapor per hour. With drawing the vapor at a faster rate will frost the tank and eventually the burner will run out of fuel.

Hose sizing Vapor Propane

- Up to 50', use 3/4" or larger hose

For Natural Gas applications you must know the available line pressure and pipe inside diameter. Call the factory for the proper size of orifice, gas manifold and hose.

Vapor Propane and Natural Gas Units can be used inside the building or outside.

- Wire heater directly into fused disconnect
- | | | |
|---------------------------|--------|-------------|
| Power Supply line sizing: | | |
| 4210 - 240V - under 75' | 8 ga. | 3 conductor |
| 75 ft to 100 ft | 6 ga. | 3 conductor |
| 4200 - 480V - under 75' | 10 ga. | 4 conductor |
| 75 ft to 150 ft | 8 ga. | 4 conductor |

Position heater properly before use.

Install heater in a horizontal position. Clearances required for combustibles and containers.

Front Outlet	12 ft
Intake	2 ft
Sides	2 ft
Top	4 ft

For your safety do not use this heater in a space where gasoline or other liquids, having flammable vapors, are stored or used.

It is best to provide outside clean air to heater inlet and adequate ventilation to heated areas. The hose assembly shall be protected from traffic, damage, building materials and contact with hot surfaces.

Check all connections for leaks.

Turn off fuel supply and burn out leftover fuel in hose when heater is not in use.

Heater can be ducted up to 400 ft of **straight** 27" duct. For every 90° bend cut the total length in half.

If the heater is ducted it may be necessary to adjust the air flow switch (located inside control box) by turning adjusting screw CCW until the light on the control box turns on.

If the heater is equipped with a Hi/Lo Fire Thermostat, place the thermostat inside the area to be heated, then set desired temperature. Heater will cycle from high to low fire.

INSTALLATION USING A PROPANE SUPPLY TANK(S)

- 1) The propane supply system must be set up for vapor withdrawal from the operating tank(s). Liquid propane can cause the heater to overfire and will damage valve train components, unless unit is supplied with a built in vaporizer.
- 2) The heater must be at least 6 ft. from any LP-Gas container, and not directed toward any LP-Gas container within 20 ft.
- 3)

<u>Minimum Tank Size</u>	<u>Outdoor Temperature</u>
500 Gal.	Above +25°F
1000 Gal.	+25°F to + 10° F
2 x 1000 Gal.	Below +10°F
- 4) The installation must conform with local codes, or in the absence of local codes, with the Standard for Storage and Handling of Liquefied Petroleum Gases ANSI/NFPA 58.
- 5) Turn off the propane supply valve at the tank(s) when the heater is not in use.
- 6) When the heater is to be stored indoors the propane tank(s) must be disconnected from the heater and the tank(s) stored in accordance with Chapter 5 of the above National Standard.



COMMON INSTALLATION AND OPERATIONAL PROBLEMS

1) LOW VOLTAGE AT THE HEATER

This is one of the most common problems and is usually the result of the supply cord having too small a wire gauge for its length, or low voltage at the power source. Low voltage results in the motor overheating, burnt relay contacts, or a relay that will not make contact. Check voltmeter on heater before start-up.

2) SUPPLY LINE TOO SMALL

Minimum Size: 1/2" for LP, 3/4" for Natural Gas.

3) INSUFFICIENT VAPORIZATION AT SUPPLY

Normally caused by undersized supply tank.

4) IMPROPER GAS SUPPLY PRESSURE

Usually a result of propane supply pressure being too high because of improper or lack of regulation or too low of natural gas pressure at meter.

5) DIRTY GAS SUPPLY

Dirty gas can cause strainers to plug or form a build-up in the burner orifice.

6) LACK OF PREVENTIVE MAINTENANCE

Heaters must be cleaned as required, especially when used in a dirty environment.

7) IMPROPER SUPPLY OF FRESH AIR

It is strongly recommended that the intake air of the heater be taken from outside the enclosed area. This provides a slight pressurization and prevents any problems associated with recirculation of products of combustion.

OPERATING INSTRUCTIONS

Model 4200 Series

ON

1. Turn on fuel supply
2. Turn on the manual shut off valve
3. Turn on the fan switches
4. Turn on the burner switch.

OFF

1. Turn off fuel supply
2. Turn off the burner switch
3. Turn off the fan switch

MODEL 4200 SERIES
SEQUENCE OF COMPONENT OPERATION

- 1) **POWER SUPPLY**
240/480 Volt wire directly into the fused disconnect.
- 2) **FUSE DISCONNECT SWITCH**
Turned on, it sends power to motor relay and to control voltage transformer.
- 3) **CONTROL VOLTAGE TRANSFORMER**
Sends power to the 3 amp circuit breaker.
- 4) **3 AMP CIRCUIT BREAKER**
Sends power to the fan switch.
- 5) **FAN SWITCH**
Sends power to the motor relay holding coil.
- 6) **MOTOR RELAY**
Closes, the fan motor starts, there is power at the burner switch.
- 7) **BURNER SWITCH**
In the ON position it sends power to the air flow switch.
- 8) **AIR FLOW SWITCH**
It was blown closed by the fan turning, sends power to the ignition control board.
- 9) **IGNITION CONTROL BOARD**
Creates a spark at the igniter and sends power to the high limit switch.
- 10) **HIGH LIMIT SWITCH**
Sends power to the gas solenoid valve.
- 11) **GAS SOLENOID VALVE**
Opens, sending fuel to the burner (where there is spark).
- 12) **BURNER**
It ignites.
- 13) **IGNITER SENSOR**
Sends a flame sensing signal to the ignition control board. The unit is operating.

TROUBLE SHOOTING

NOTE: MUST CHECK COMPONENTS IN SEQUENCE LISTED

DIRECTIONS: Find the specific **symptom**. Refer to **Sequence of component Operation Guide**. Check the components listed with a **voltmeter** for proper operation as described. Replace any components not operating correctly.

Fan will not start when fan switch and thermostat are ON.

- Check sequences 1 through 5 (Page)
- Push reset button on Motor Overload Relay

Fan runs, no spark for ignition.

- Check sequences 6 through 9 (Page)
- Check continuity of igniter leads. Replace if shorted or broken.
- Check igniter for carbon buildup, gap spacing (1/8"), secure mounting
- Replace igniter if porcelain is cracked or if electrodes are rubbery

Have spark but no flame.

- Check sequences 9 through 11 (Page)
- Check for gas pressure on the manifold gauge, if gas is present, clean the burner port holes

Flame occurs but burner locks out after a few seconds.

- Check burner ground wire (Bad connections)
- Check sensor wire (Burned wire or bad connection)
- Check igniter/sensor (Replace if probe is rubbery)
- Clean port holes in burner around igniter/sensor
- Replace ignition control board

Flame occurs but trips pressure reset button after 30 to 40 seconds.

- Pressure regulator is set too high.
- Limit switch shuts burner off.
- Adjust pressure regulator to proper setting. (1"W.C. LP Max, 2.5" W.C. Nat. Max)
- Indicator light will glow when proper setting is obtained.

Flame established, but too small.

A: Check for proper pressure at manifold gauge — (if yes)

1. Clean port holes in burner

B: Not enough pressure at manifold gauge.

1. Check fuel supply
2. Check liquid strainer — Filter at the "Y" fitting. (Liquid Propane model only) for restriction from dirt, oil, etc.
3. Check high pressure regulator for similar restriction.
4. Check gas solenoid valve for similar restrictions.

PREVENTATIVE MAINTENANCE

- 1) **Check - Fused disconnect**
 - A) Continuity through fuses.
- 2) **Check - All wiring for tight and correct connections**
- 3) **Check - Motor Relay**
 - A) If it buzzes, clean contacts or replace.
 - B) Check for voltage drop through L1 & T1 contacts. If it's more than 2 volt replace.
- 4) **Check - Air Flow Switch**
 - A) Clean inlet and negative pressure tubes (Blow out with air)
 - B) Adjust the switch, turn adjusting screw CCW until the light on the control panel stays on.
- 5) **Clean the burner**
 - A) Clean port holes (gas outlet)
 - B) Clean air mixture holes (Main burner section)
- 6) **Clean and inspect solenoid valves**
 - A) Remove tops of solenoid valves, clean dirt and propane oil out
 - B) Inspect diaphragm (Not hard or cracked)
- 7) **Check/Replace the igniter/sensor**
 - A) Move sensor probe with fingers. If "rubbery" replace it.
 - B) If probe solidly rigid, clean igniter and check gap @ 1/8"
- 8) **Check for gas leaks**
 - A) Heater operating, check for leaks at all pipe joints with leak detector or soapy water. Remake joints where bubbles occur.
- 9) **Tighten all bolts**
 - A) Motor mounts
 - B) Fan blade
 - C) Burner mount
 - D) Pipe train (manifold) mounts

Model 4200 Series

ITEM	PART#	DESCRIPTION
1	HWP HC1069B	LID FOR CONTROL BOX
2	HWP HC1069A	CONTROL BOX LID
3	N/S	COPPER TUB/AIR SWITCH
4	HWP HP1048	FAN BLADE (SPECIFY HP)
5	HWP HG1051	FAN GUARD
6	HWP HM1078	MOTOR 7.5 HP 1 PH
*	HWP HM1079	MOTOR 7.5 HP 3 PH
*	HWP HM1067	MOTOR 10 HP 1 PH
*	HWP HM1068	MOTOR 10 HP 3 PH
*	HWP HM1071	MOTOR 15 HP 3 PH
*	HWP HM1080	MOTOR 20 HP 3 PH
7	HWP HC1009	HI LIMIT SWITCH
8	HWP HB4200	BODY
9	HWP HB1070	BURNER
10	HWP TT-3	TRAILER
11	HWP HD1055B	DISCONNECT 60 AMP 1PH
*	HWP HD1057B	DISCONNECT 60 AMP 3PH
*	HWP HD1057	DISCONNECT 30 AMP 3PH
12	HWP HV1067	VAPORIZER RING

* Items not shown on breakdown

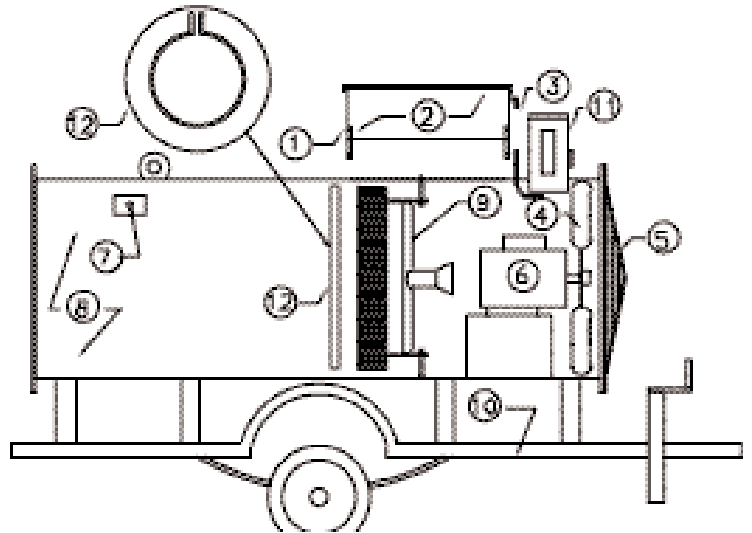

Model 4200 Series Control Box

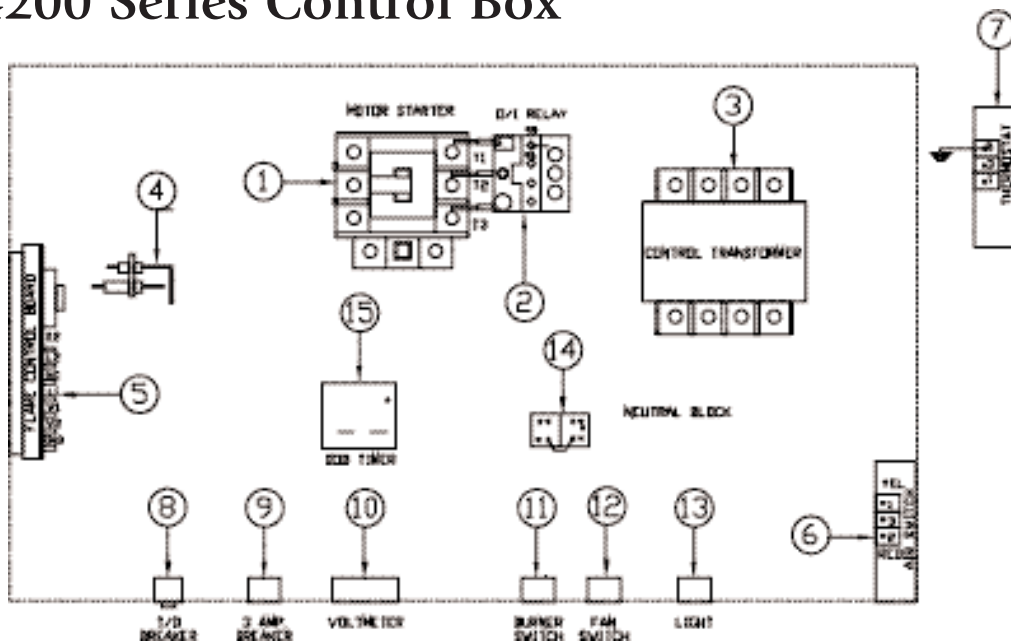

ITEM	PART#	DESCRIPTION
1	HWP HS1046	MOTOR RELAY (3PH)
*	HWP HS1045	MOTOR RELAY (1PH)
2	HWP HS1046B	OVERLOAD RELAY (3PH)
*	HWP HS1045B	OVERLOAD RELAY (1PH)
3	HWP HC1017	CONTROL TRANSFORMER
4	HWP HC1004B	IGNITER (FENWALL)
5	HWP HC1001C	D.S.I. CONTROL BOARD
6	HWP HC1010	AIR FLOW SWITCH
7	SFP 2453	HI-LO THERMOSTAT
8	HWP HC1072	TIME DELAY BREAKER
9	HWP HC1019B	3 AMP BREAKER
10	SFP 5989	VOLT METER (150 VOLT)

ITEM	PART#	DESCRIPTION
11	HWP HC1011	BURNER SWITCH
12	HWP HC1011	FAN SWITCH
13	SFP 2505	LIGHT
14	HWP 099125-03	NEUTRAL BLOCK
15	HWP HC1077	DELAY BREAK TIMER
*	HWP HS1046BM	BRACKET MOUNTING KIT
*	HWP HS1046C	OVERLOAD RELAY PRIOR TO 1991
*	HWP 2453A	THERMOSTAT SUB. ASSEMBLY W/15' 16/3 CORD

* Items not shown on breakdown

4200 Series L.P. Pipe Train

ITEM	PART#	DESCRIPTION
1	HWP HV1042B	HOSE ASSEMBLY
2	HWP HV1037	1/2" LIQUID PROPANE SOLENOID VALVE
3	HWP HV1023	MANUAL SHUT-OFF VALVE
4	HWP HV1054	200 PSI GAUGE
5	HWP HV1029	1/2" LIQUID STRAINER
6	HWP HV1023	1/2" MANUAL SHUT-OFF VALVE
7	HWP HR1053	REGULATOR
8	HWP HV1025	1/2" SOLENOID VALVE
9	HWP HV1076	1/2" HI-LO VALVE (DRILLED AT 1/4")
10	HWP HV1075	GAS PRESSURE LIMIT SWITCH
11	HWP HV1027	30 PSI VAPOR PRESSURE GAUGE
*	HWP 1038	115V REPLACEMENT COIL FAN FOR HV1037

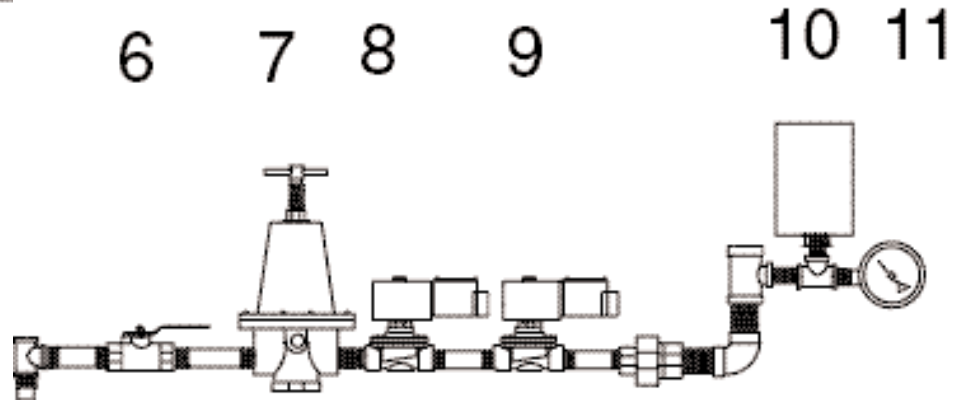
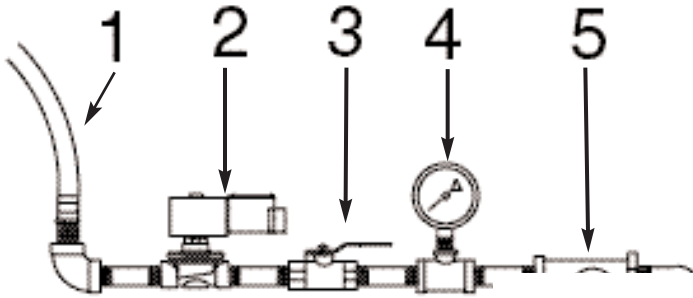

4200 Series Natural Gas Pipe Train

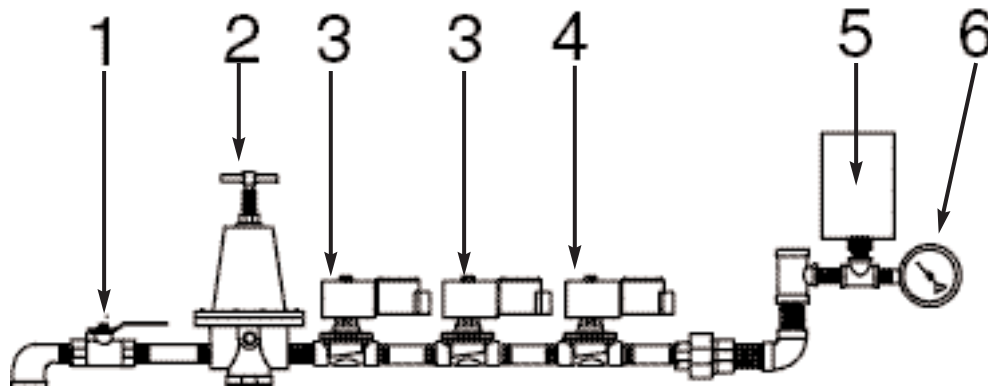

ITEM	PART#	DESCRIPTION
1	HWP HV1023	BALL VALVE
2	HWP HR1053	REGULATOR
3	HWP HV1025	1/2" SOLENOID VALVE
4	HWP HV1076	1/2" HI-LO VALVE (DRILLED AT 3/8")
5	HWP HV1075	GAS PRESSURE LIMIT SWITCH
6	HWP HV1027	30 PSI VAPOR PRESSURE GAUGE

480 Volt 3 PH

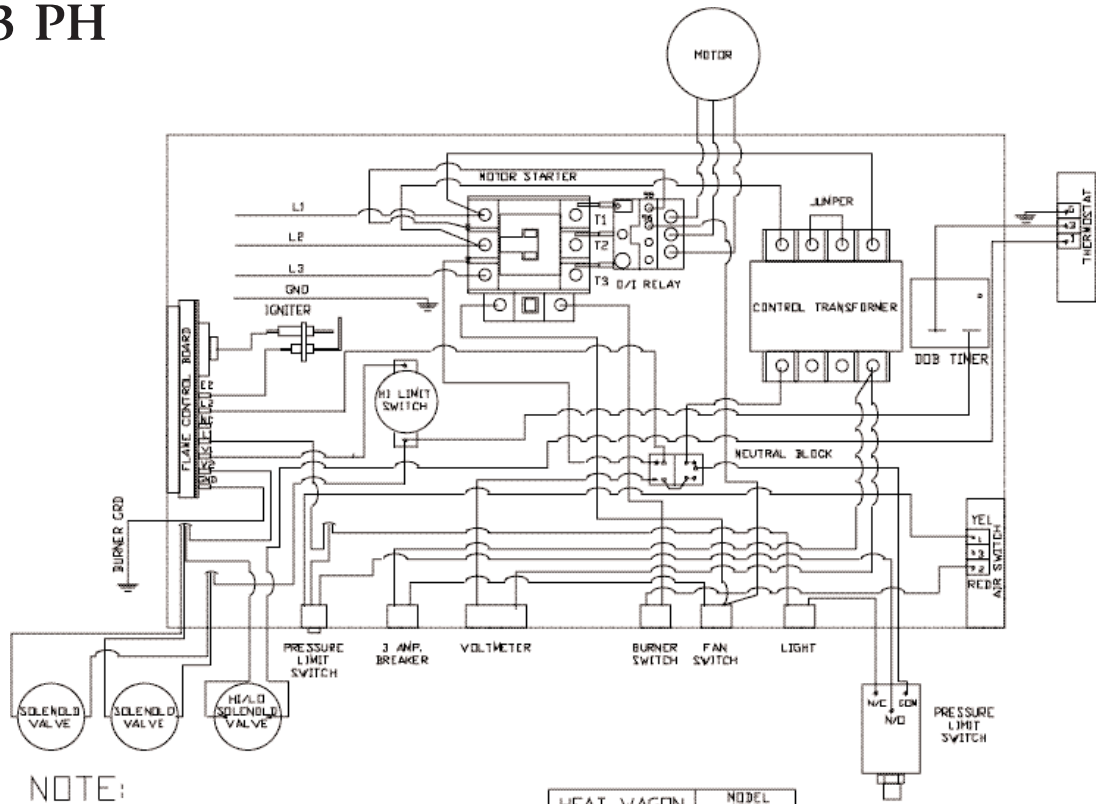

NOTE:
ALL 16 GA. STR. IEW 600V,
UNLESS OTHERWISE SPECIFIED

HEAT WAGON	MODEL 4200
DATE OF DRAWING 1998	FROM TO
4200CWD	92 CURR.

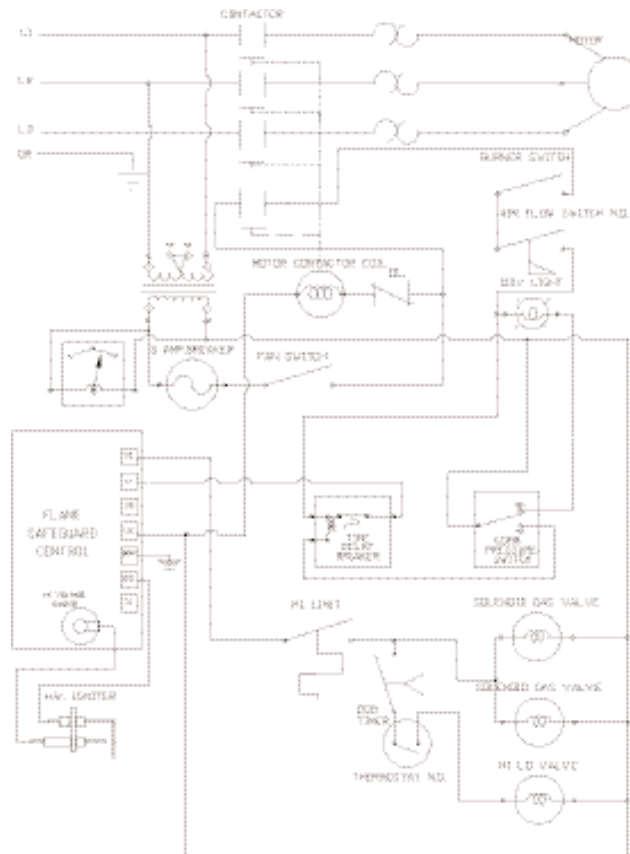

HEAT WAGON	MODEL 4200
DATE OF DRAWING 1998	FROM TO
4200243P	1992-CURR.

240 Volt 3 PH

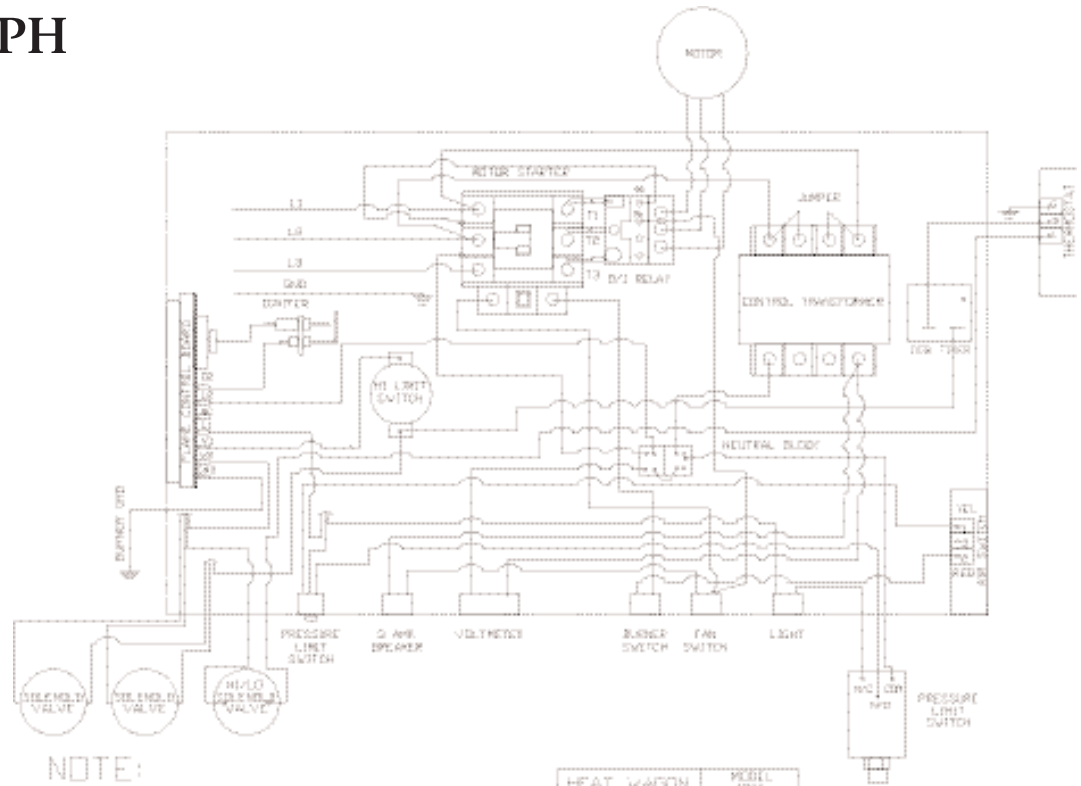

NOTE:
ALL 16 GA. STR. IEW 600V,
UNLESS OTHERWISE SPECIFIED

HEAT WAGON	PROJECT
DATE OF DRAWING 1998	FROM TO
4200CWD3	92 CURR.

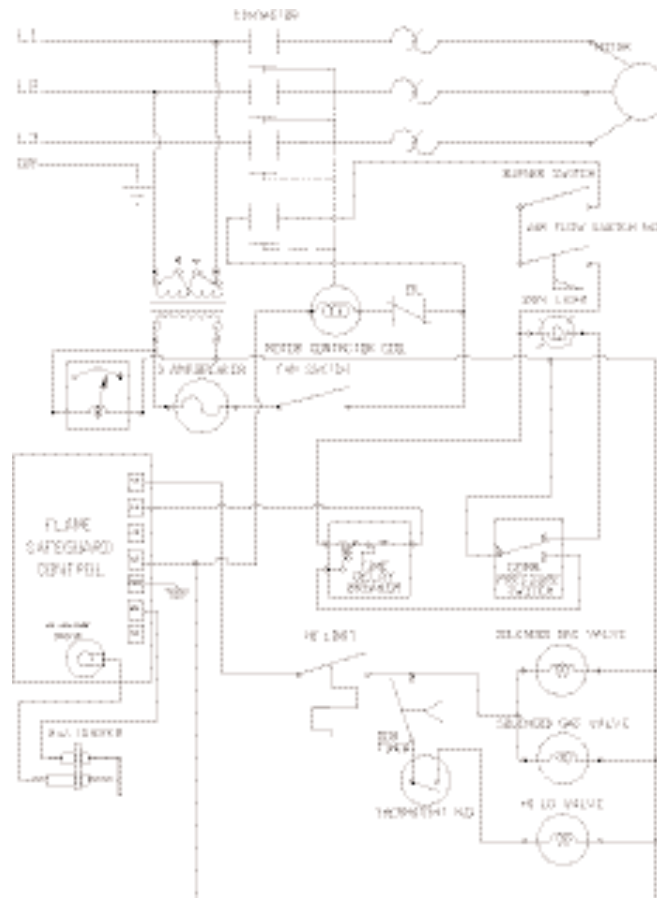

HEAT WAGON	PROJECT
DATE OF DRAWING 1998	FROM TO
42002403	1992-CURR.



240 Volt 1 PH

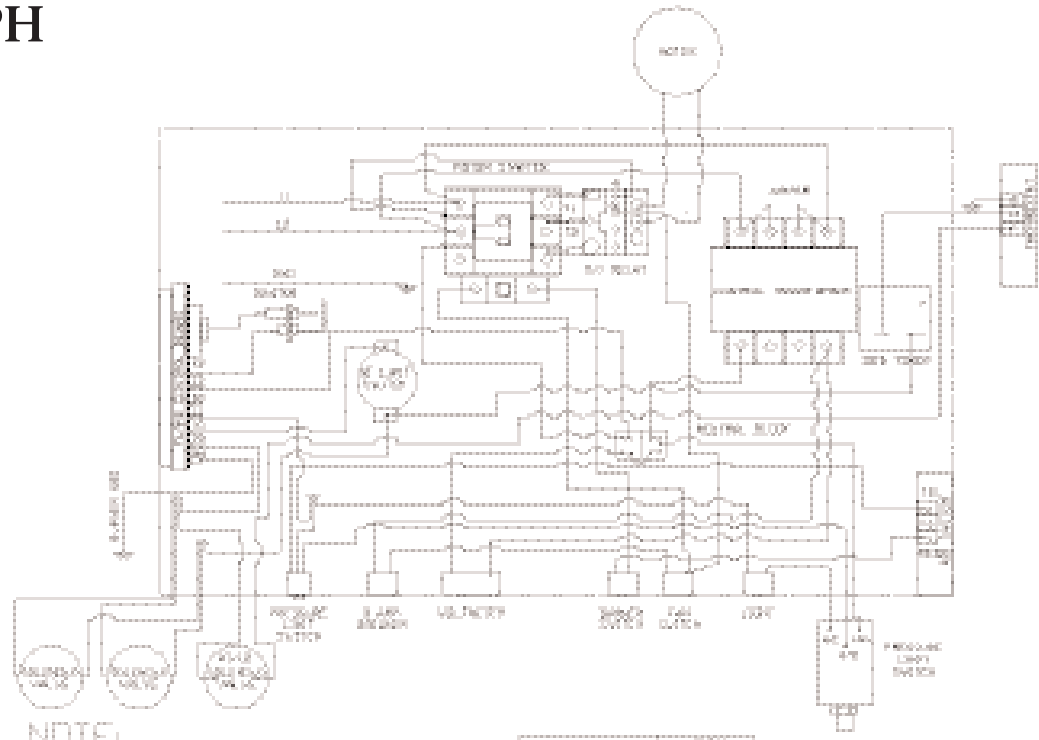

NOTE:
ALL 16 GA. STR. IEW 600V,
UNLESS OTHERWISE SPECIFIED

HEAT WAGON	MODEL
DATE OF 1998	4200
FRS 1991	FROM TO
4200WIR2	1992-CURR.

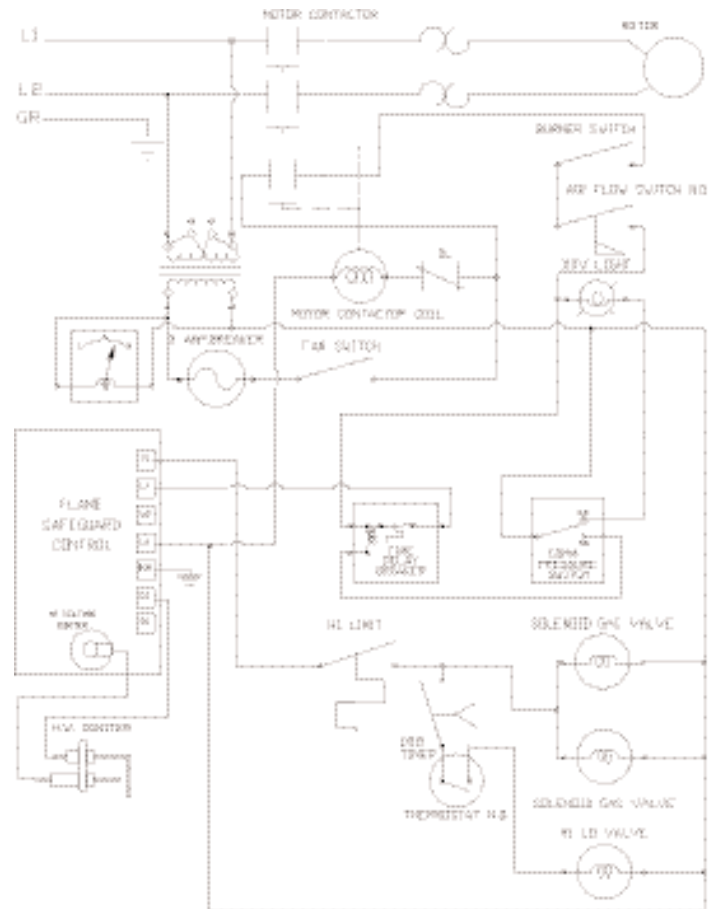

HEAT WAGON	MODEL
DATE OF 1998	4200
FRS 1991	FROM TO
4200WIR2	1992-CURR.



240 Volt 3 PH

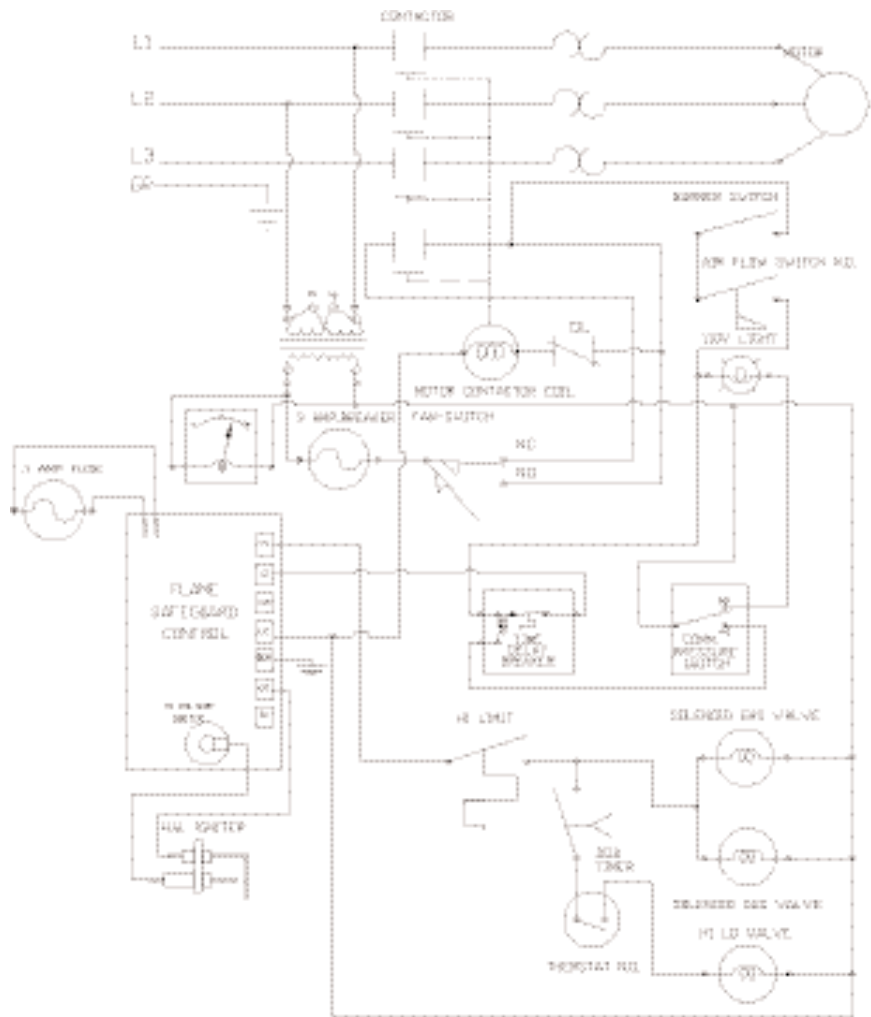

HEAT WAGON	MODEL 4200 SER.
DATE OF 1998 DRAWING	FROM TO
4200SERA	L982-1992

480 Volt 3 PH

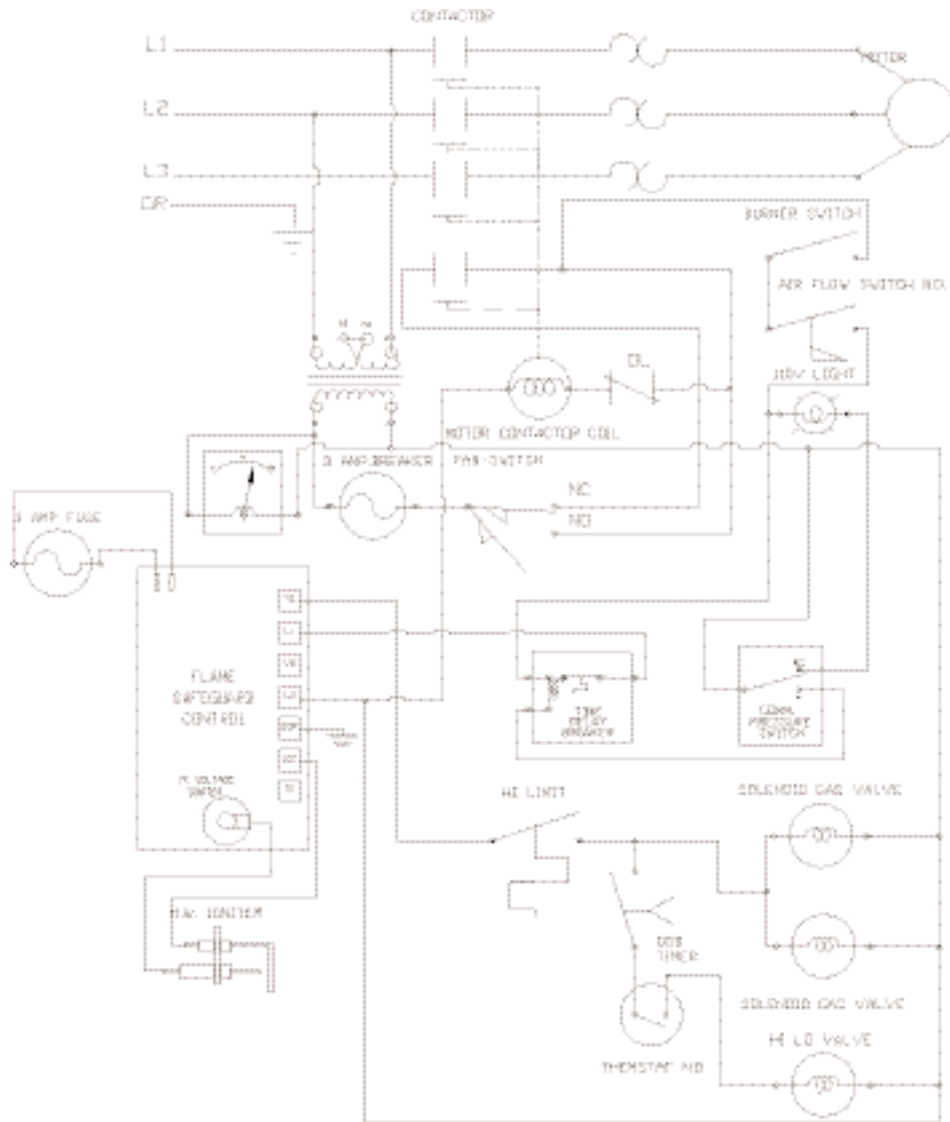

HEAT WAGON	MODEL
DATE OF DRAWING 1998	4200 SER.
4200SERB	FROM TO 1982-1992

240 Volt 1 PH

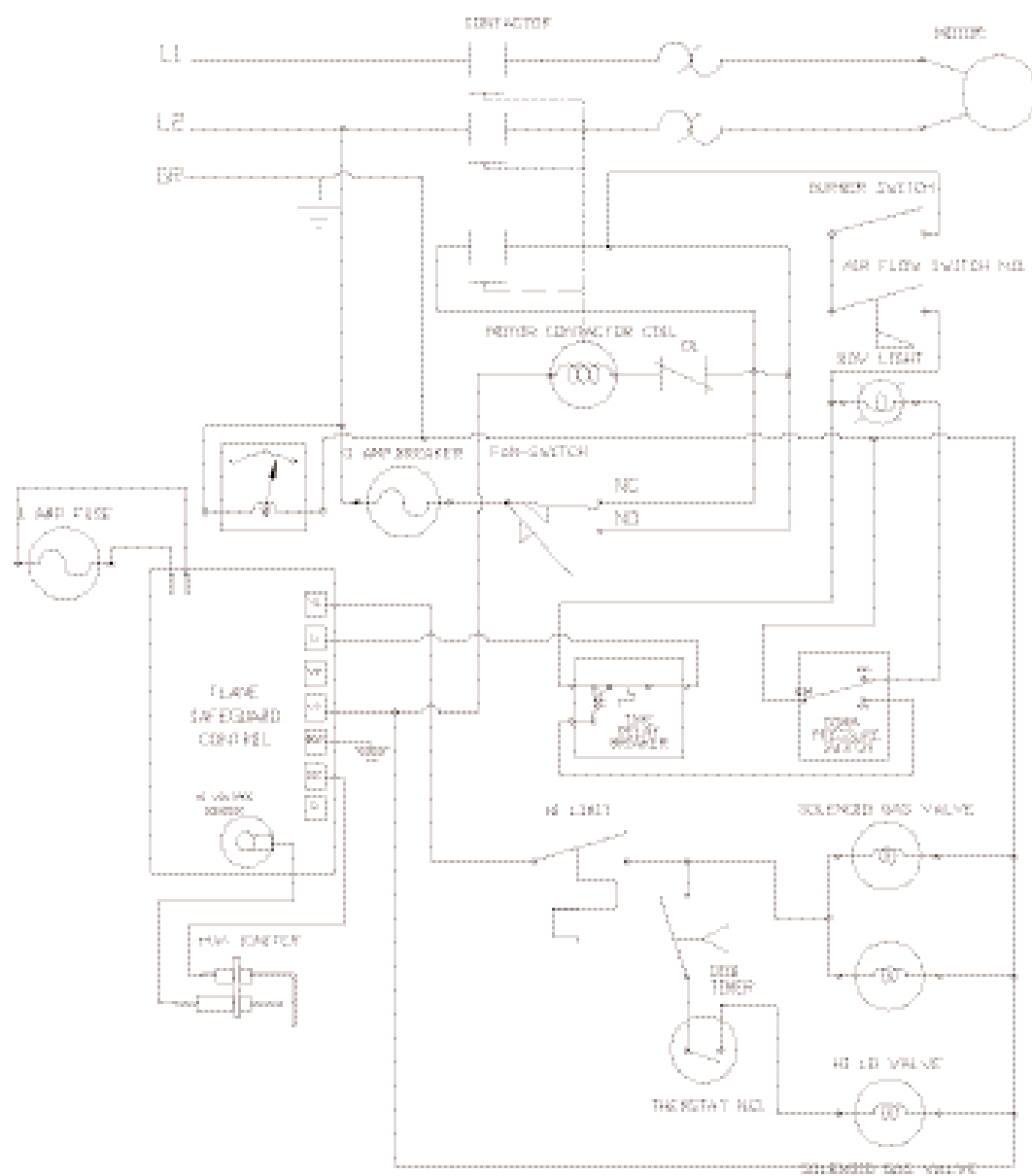

HEAT WAGON	MODEL 4200 SER.
DATE OF DRAWING 1998	FROM TO
4200SERC	1982-1992

PROPANE FACTS

LBS Per Gallon	4.24
BTU Per Gallon	91,960
BTU Per LB	21,591
BTU Per Cu Ft	2,516

Cubic feet of air Required to burn 1 Cu Ft propane	23.5
---	------

NATURAL GAS FACTS

BTU Per Cu Ft	1040
100,000 BTU = THERM	
1 THERM = 100 Cubic Foot	
Cu Ft of air required to burn 1 Cu Ft of Natural Gas	10.5

MISCELLANEOUS

BTU	.25 CALORIES
CALORIES	4 BTU'S
PSI	27.7 INCHES
1 HP	2550 BTUH
OPEN FLAME	APPROX. 3500°F
KW	3411 BTU'S

DISCHARGE TEMPERATURE OF PORTABLE OIL HEATERS	225° ABOVE AMBIENT
--	--------------------

DISCHARGE TEMPERATURE OF PORTABLE GAS HEATERS	240° ABOVE AMBIENT
--	--------------------

AMOUNT OF MOISTURE ADDED TO AIR BY PORTABLE GAS HEATER	7 LBS OF WATER PER 100,000 BTUH
--	------------------------------------